

# Barr Inc.

1423 Planeview Drive

Oshkosh, WI 54904

920-231-1711 Phone

## 25' x 40' x 12'-5"

### Drive-In Freezer

#### DRAWING INDEX

- |             |  |
|-------------|--|
| <b>T.1</b>  | <b>TITLE SHEET</b>                     |
| <b>A100</b> | <b>FLOOR/CEILING PLAN</b>              |
| <b>A200</b> | <b>INSULATED WALL PANEL ELEVATIONS</b> |
| <b>A300</b> | <b>INSULATED WALL PANEL DETAILS</b>    |

REVISION	BY	DATE

**Barr Inc.**  
1423 Planeview Drive  
Oshkosh, WI 54904  
920-231-1711 Phone

25' x 40' x 12'-5"  
Drive-In Freezer

TOLERANCES UNLESS SPECIFIED  
FRACTIONAL    DECIMAL    ANGLE  
X/16" ± 1/32"    .XX ± .015    ° ± 0'30"  
                              .XXX ± .005    ° ± 0'05"  
                              .XXXX ± .001    ° ± 0'05"

Draftsmen is not responsible for panel heights,  
widths or dimensions. Contractor to  
verify all information.

TITLE

DR. BY: KRZ

DATE: 8/1/2023

SCALE: NTS

CHECKED BY:

SHEET NO.  
T.1





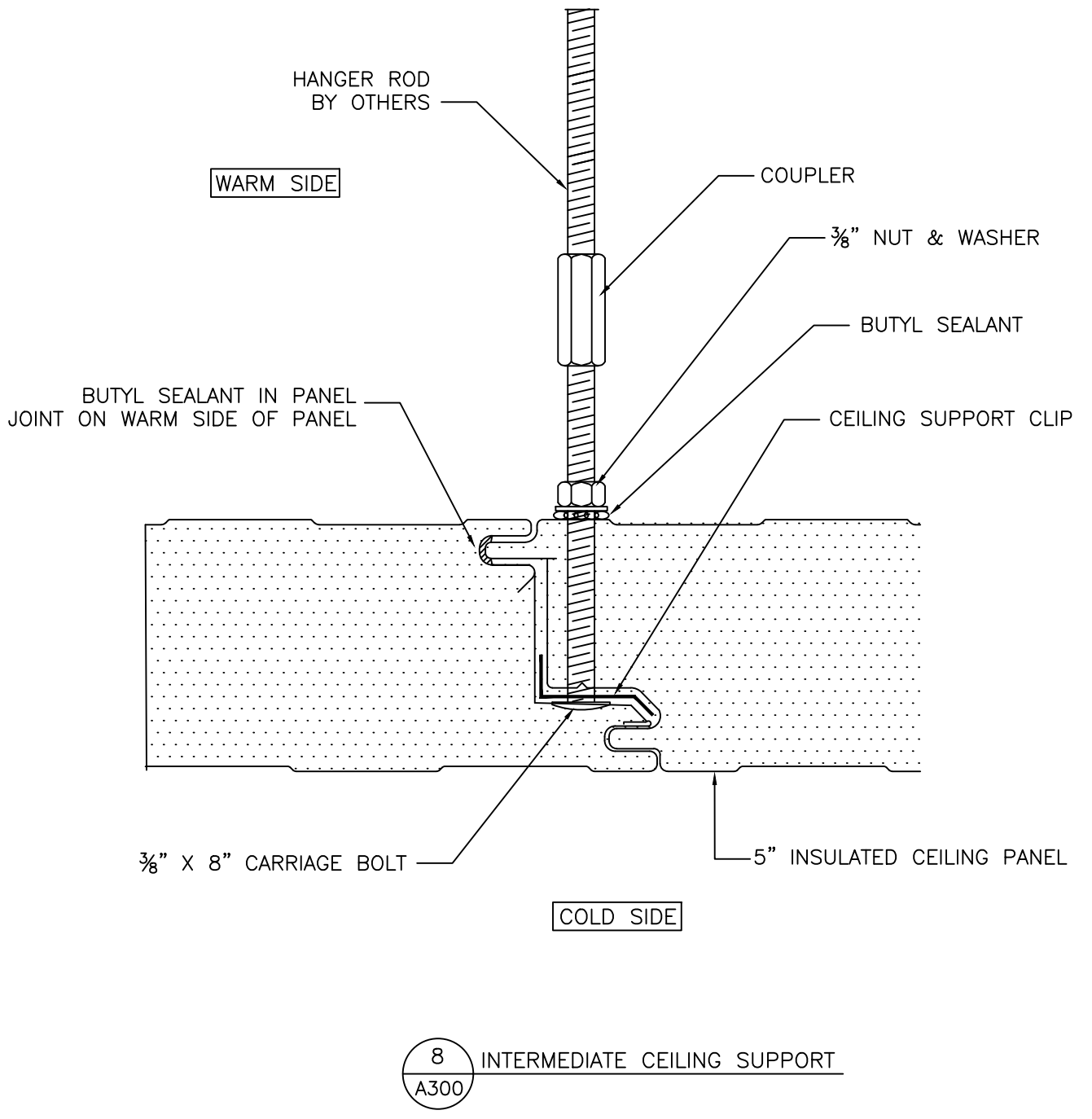
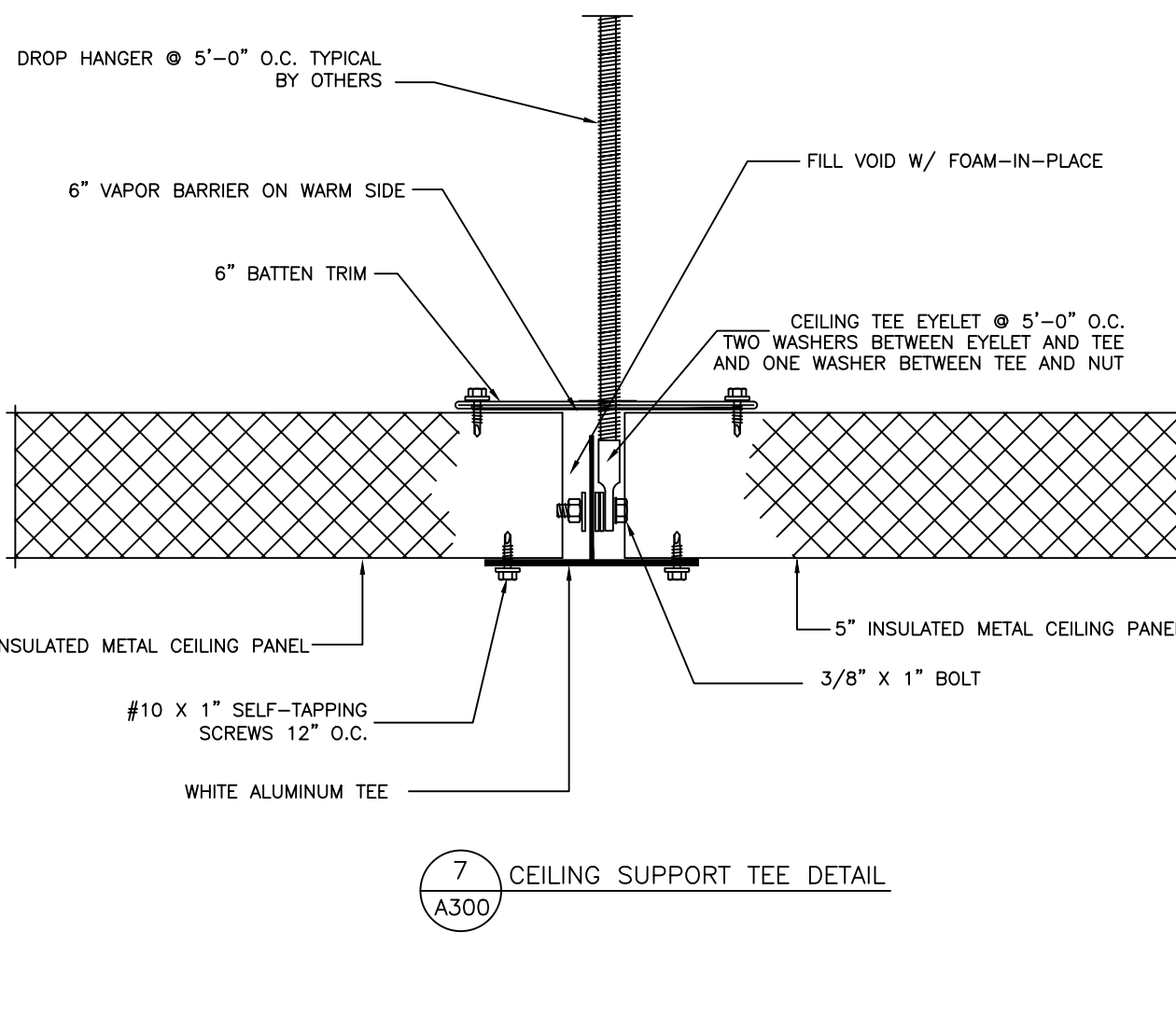
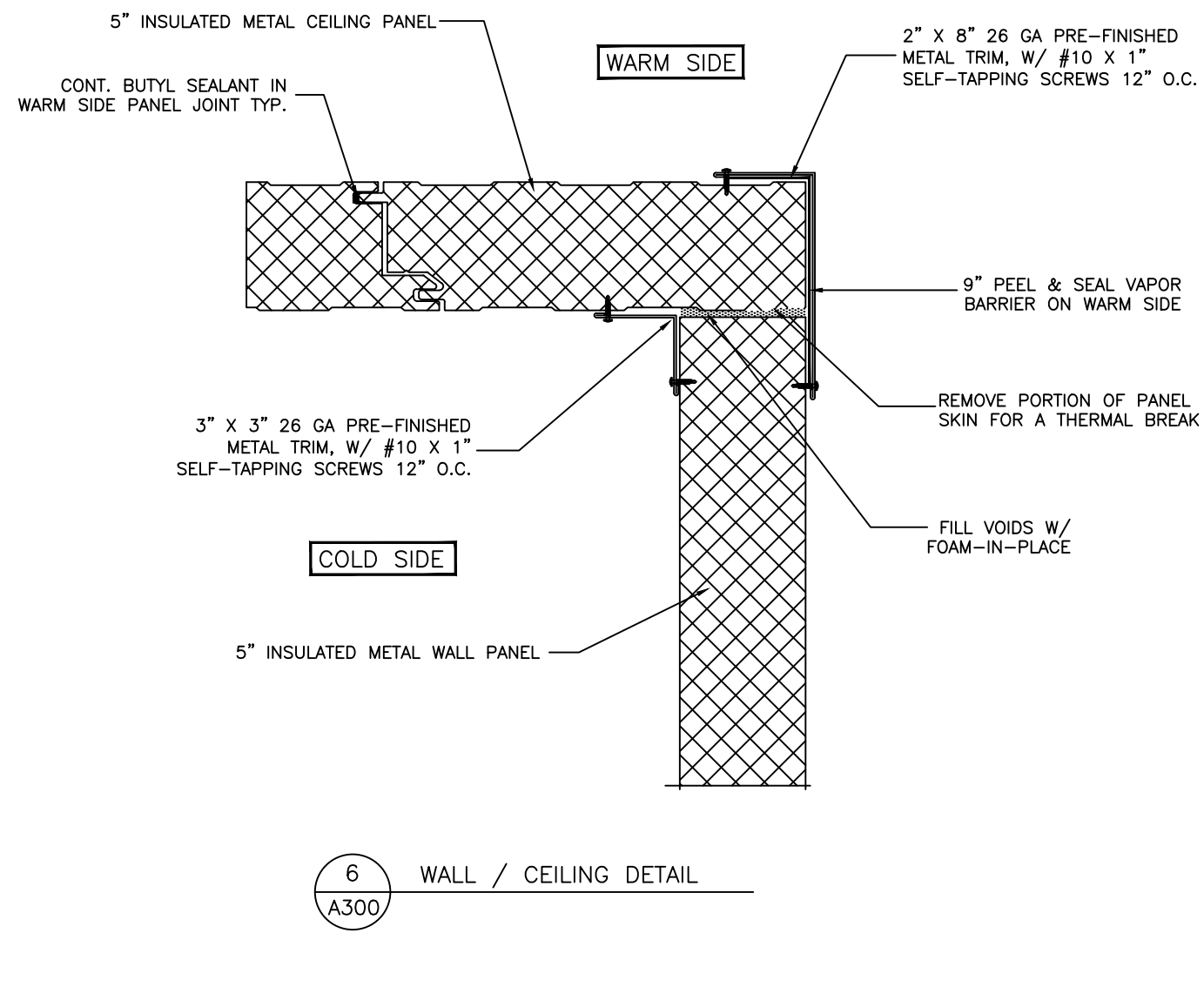
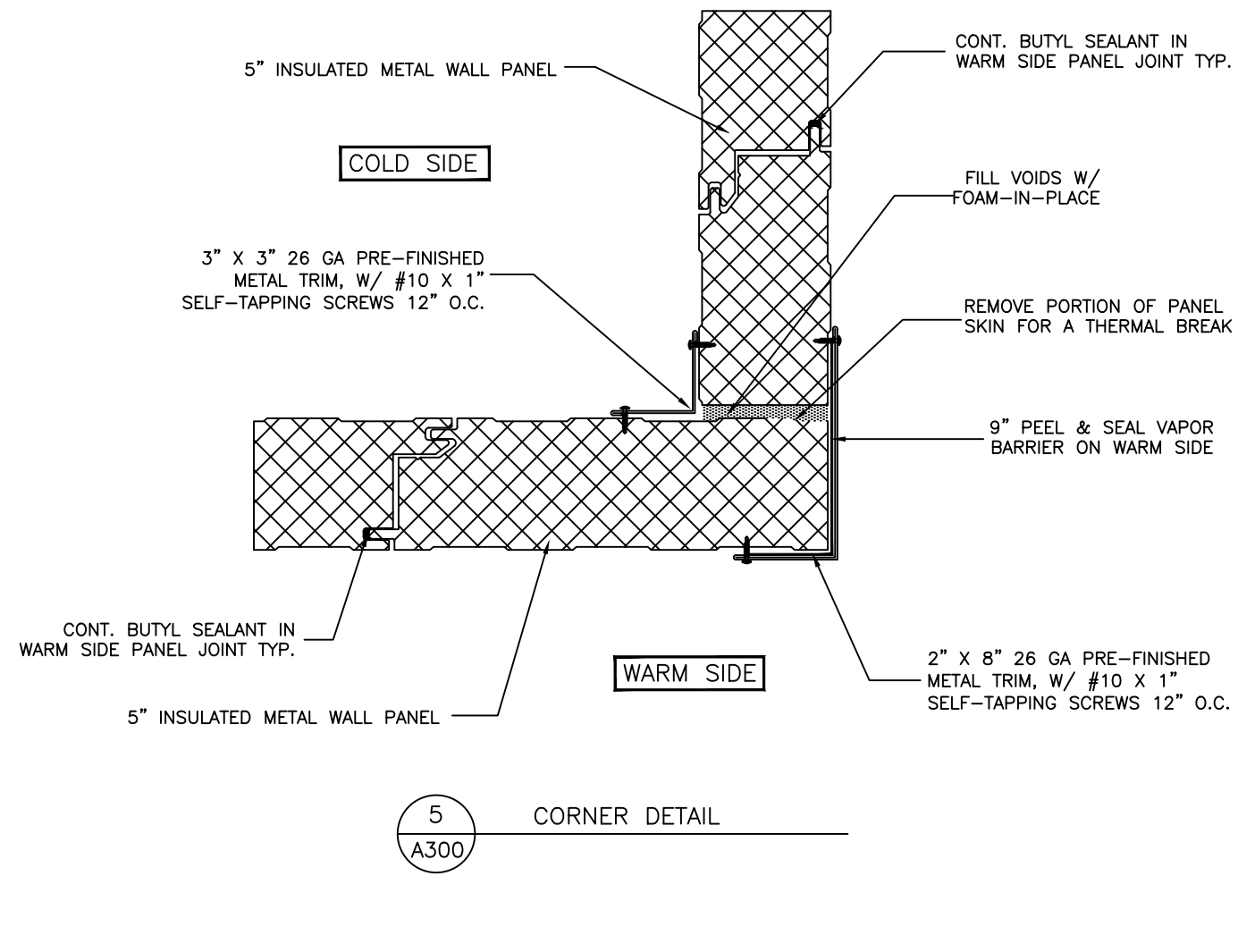
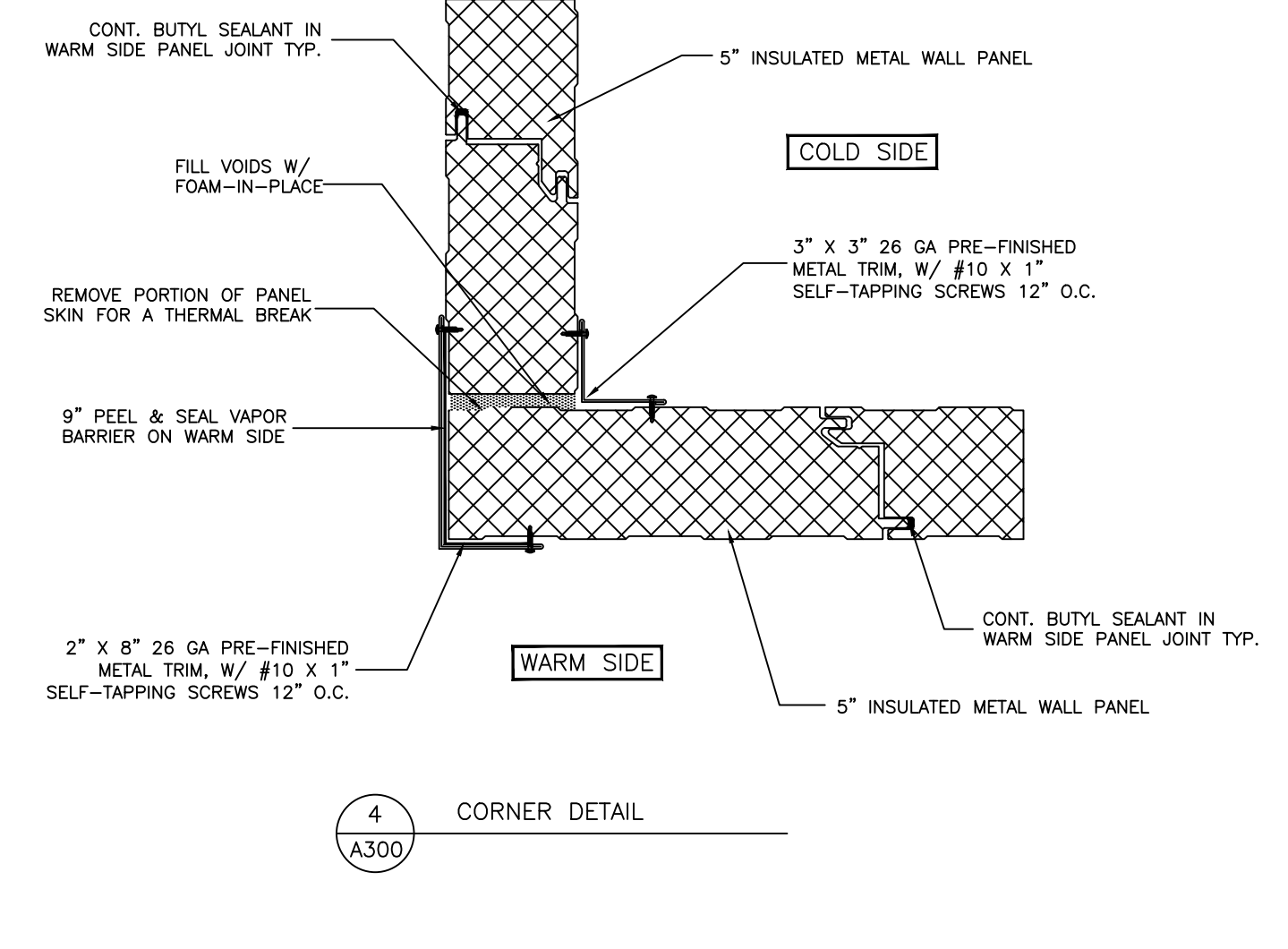
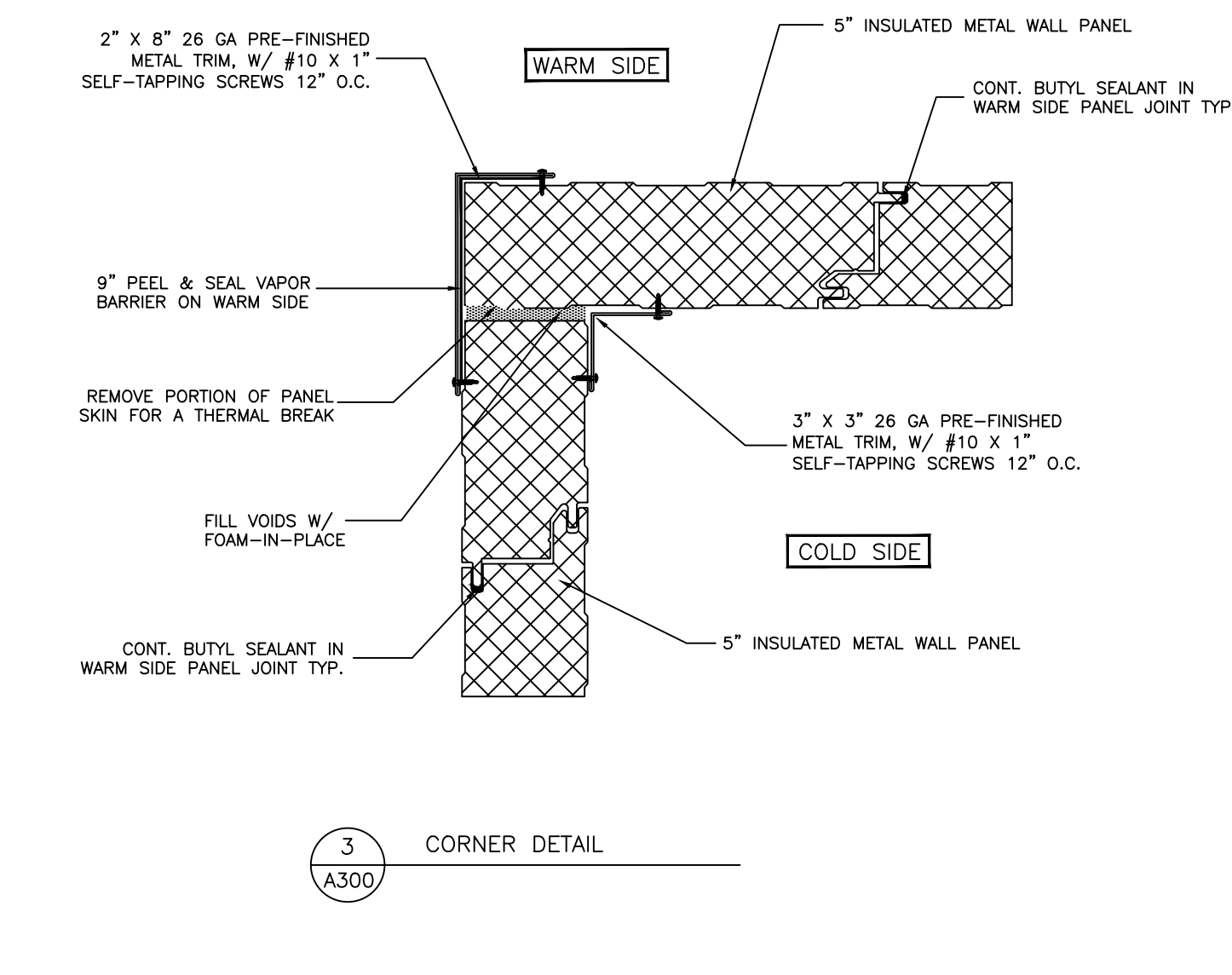
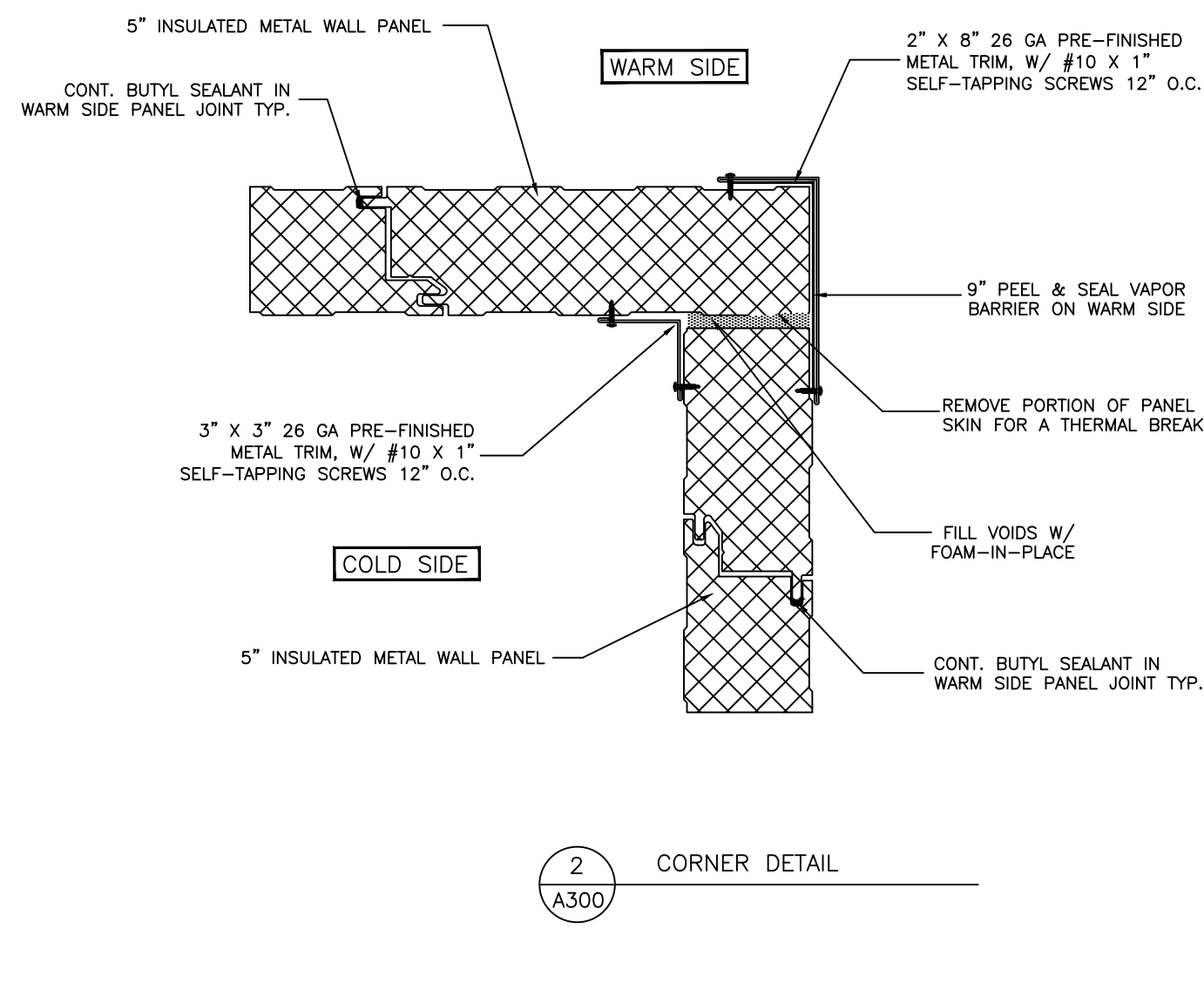
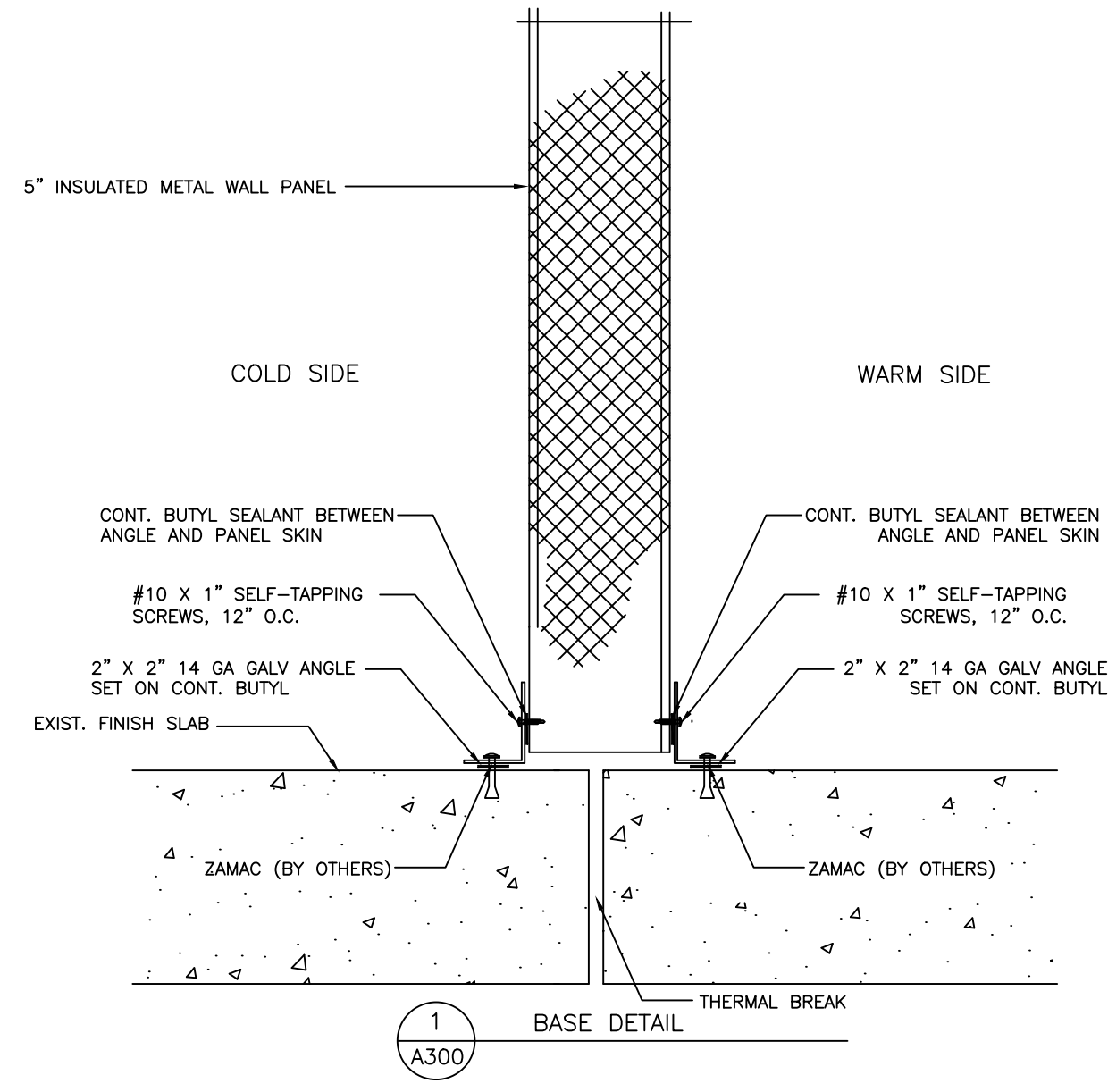

REVISION	BY	DATE

Barr Inc.  
1423 Planeview Drive  
Oshkosh, WI 54904  
920-231-1711 Phone

25' x 40' x 12'-5"  
Drive-In Freezer

TOLERANCES UNLESS SPECIFIED  
FRACTIONAL DECIMAL ANGLE  
X/X" ± 1/32" .XX ± .015 " ± 0'30"  
.XXX ± .005 "XXX" ± .005  
.XXXX ± .001

Draftsman is not responsible for panel heights, verify all dimensions. Contractor to verify all information.

WALL DETAILS

DR. BY: KRZ  
DATE: 8/1/2023  
SCALE: NTS  
CHECKED BY:  
SHEET NO. A300