

Barr Inc.
 1423 Planeview Drive
 Oshkosh, WI 54904
 920-231-1711 Phone

20' x 40' x 8'-4"
 Drive-In Cooler

DRAWING INDEX

- T.1** TITLE SHEET
- A100** FLOOR/CEILING PLAN
- A200** INSULATED WALL PANEL ELEVATIONS
- A300** INSULATED WALL PANEL DETAILS

REVISION	BY	DATE

Barr Inc.
 1423 Planeview Drive
 Oshkosh, WI 54904
 920-231-1711 Phone

20' x 40' x 8'-4"
 Drive-In Cooler

TOLERANCES UNLESS SPECIFIED
 FRACTIONAL XX ± 1/32" .XX ± .015" X ± 0°30'
 DECIMAL .XXX ± .005" XXX ± 0°05'
 .XXXX ± .001" XXXX ± .005"

Draftsman is not responsible for panel heights, quantities and/or dimensions. Contractor to verify all information.

TITLE

DR.BY: KRZ
 DATE: 8/30/2016
 SCALE: NTS
 CHECKED BY:
 SHEET NO.
 T.1

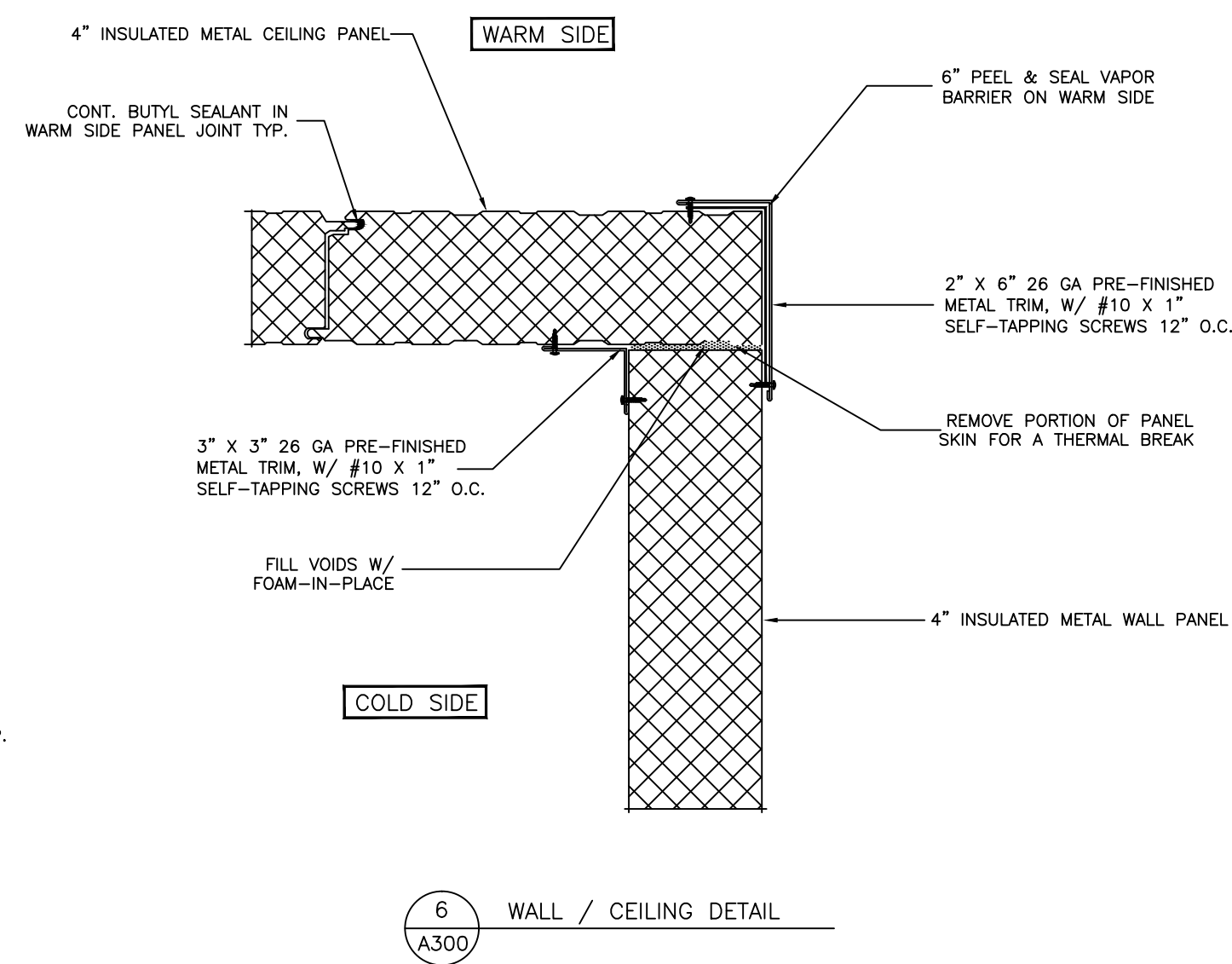
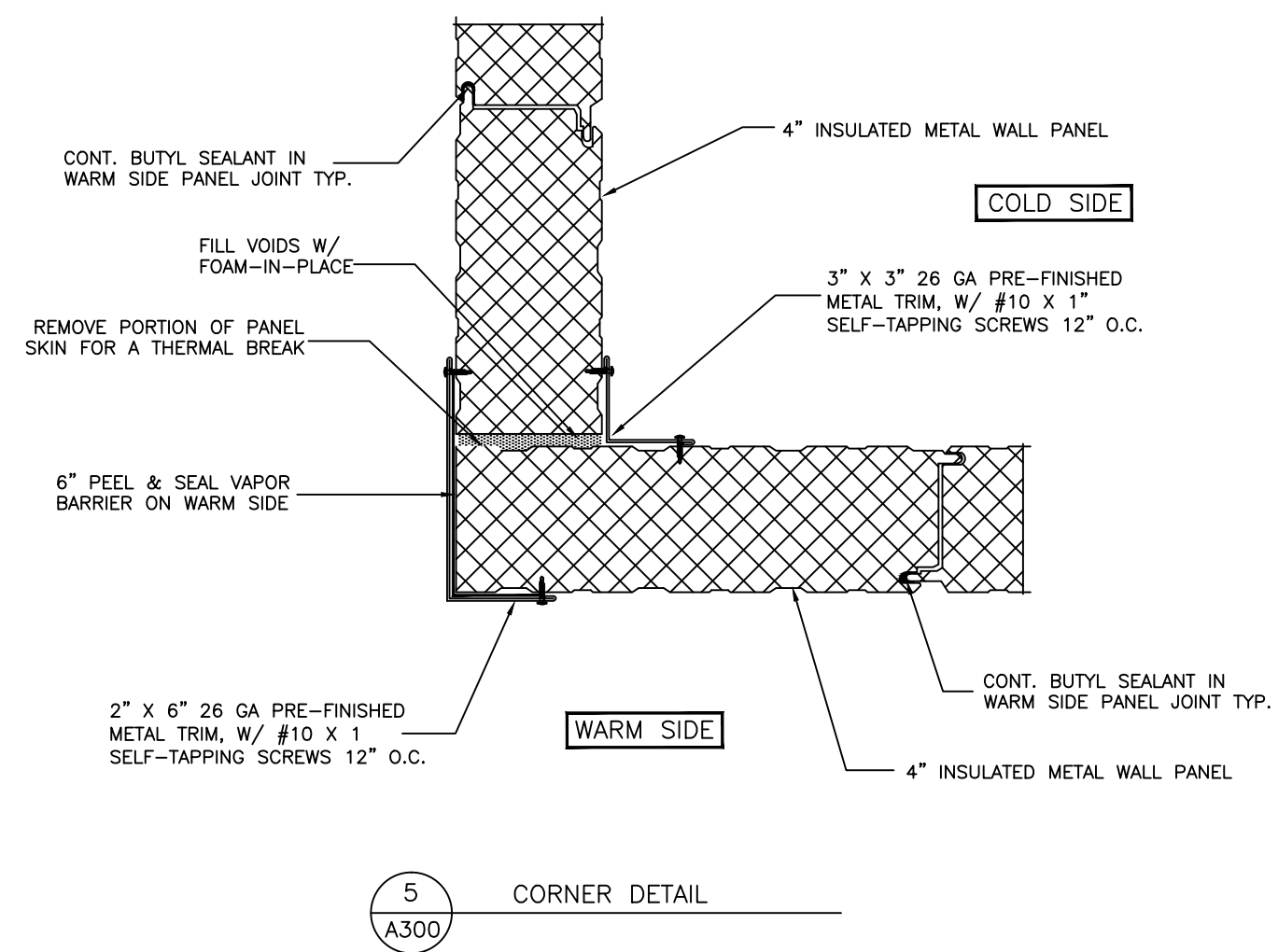
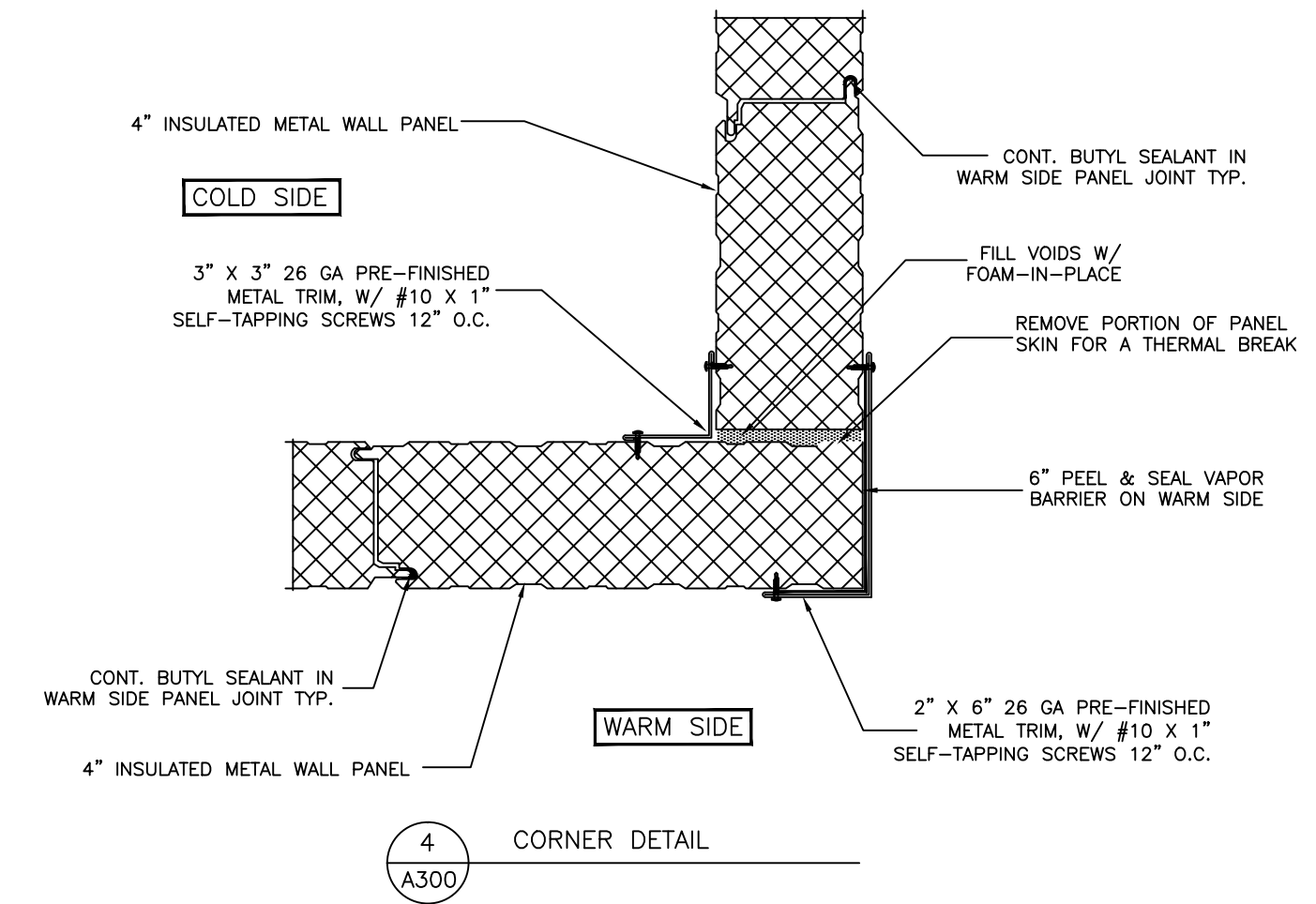
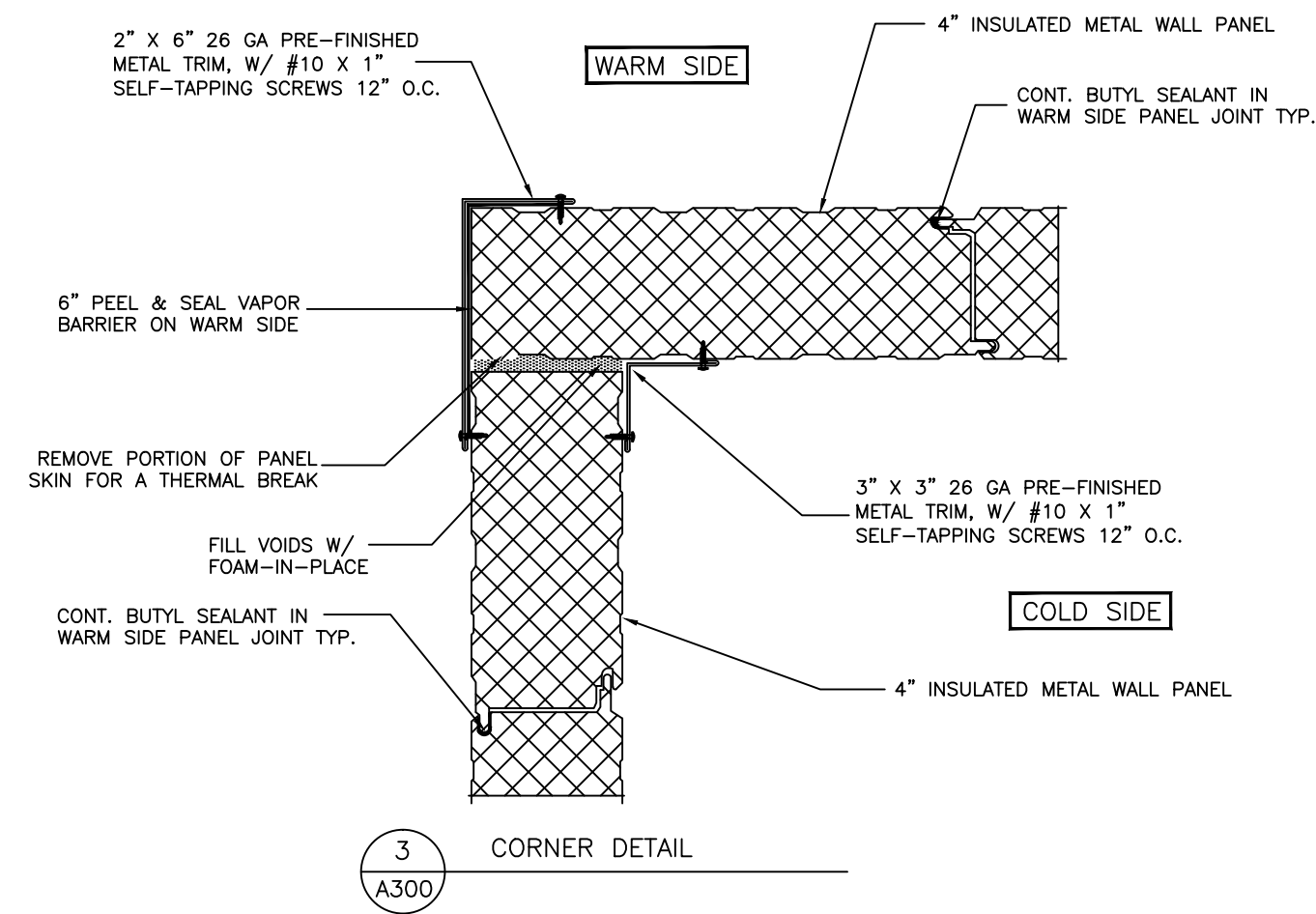
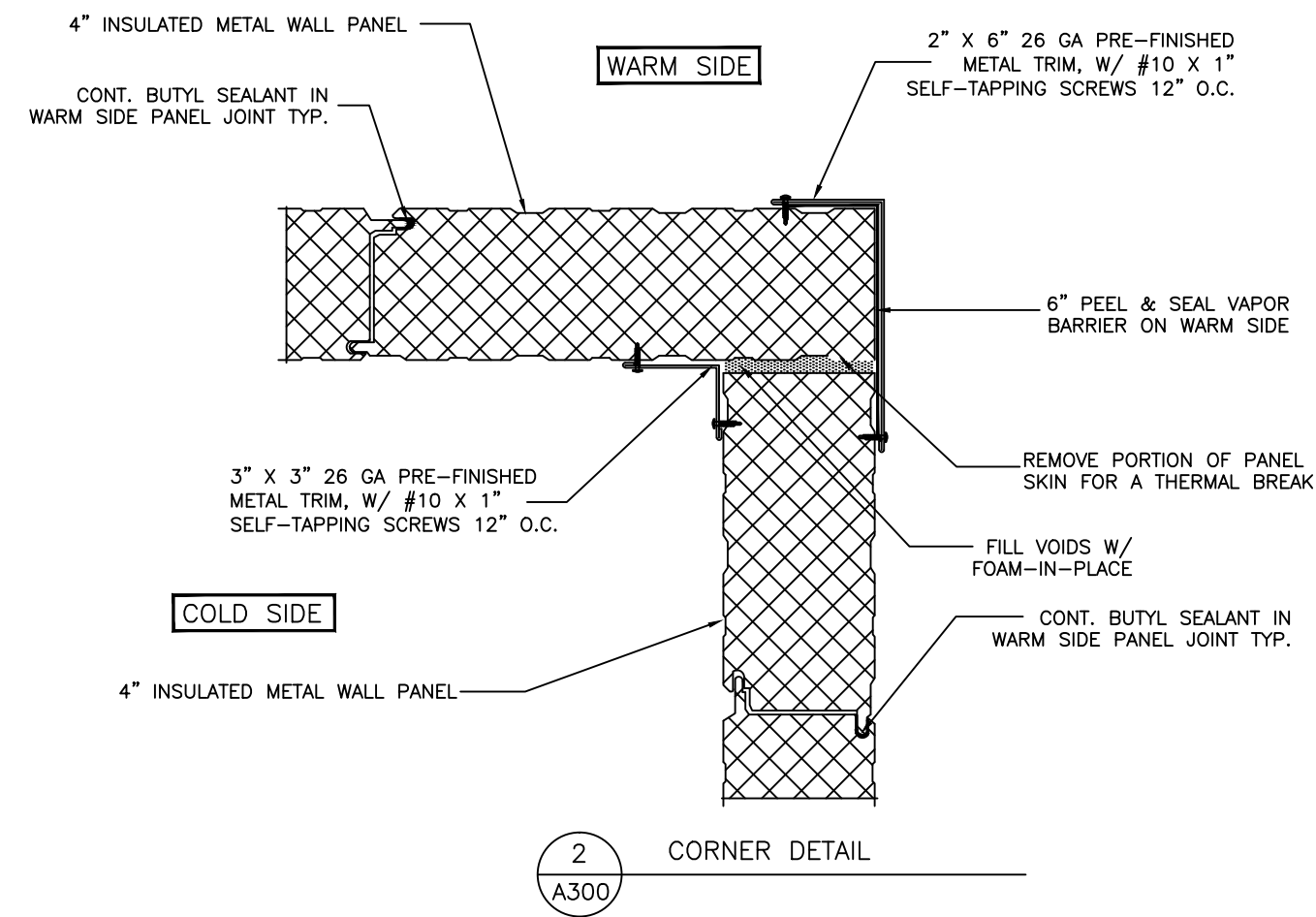
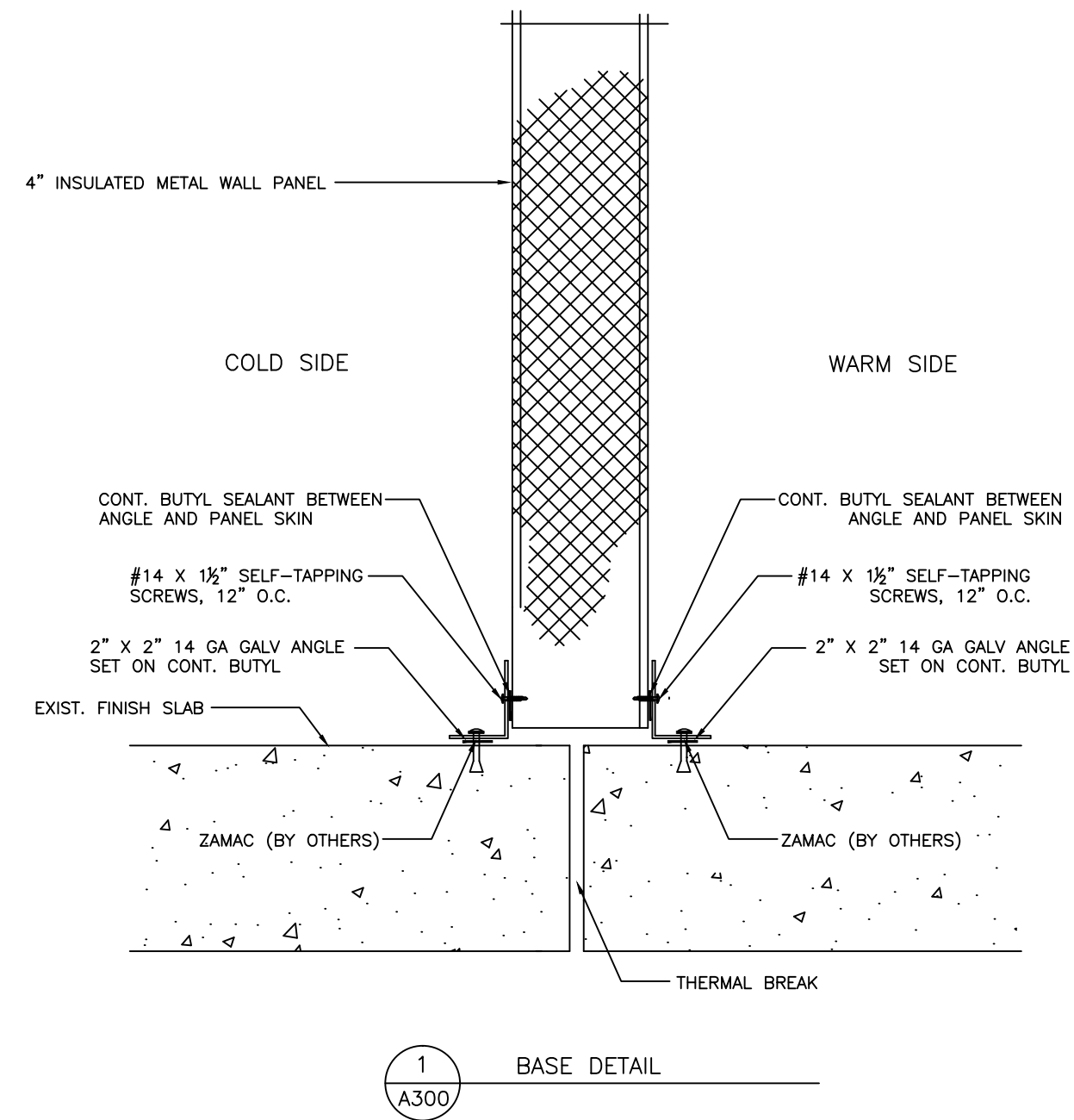

7 NOT USED
A300

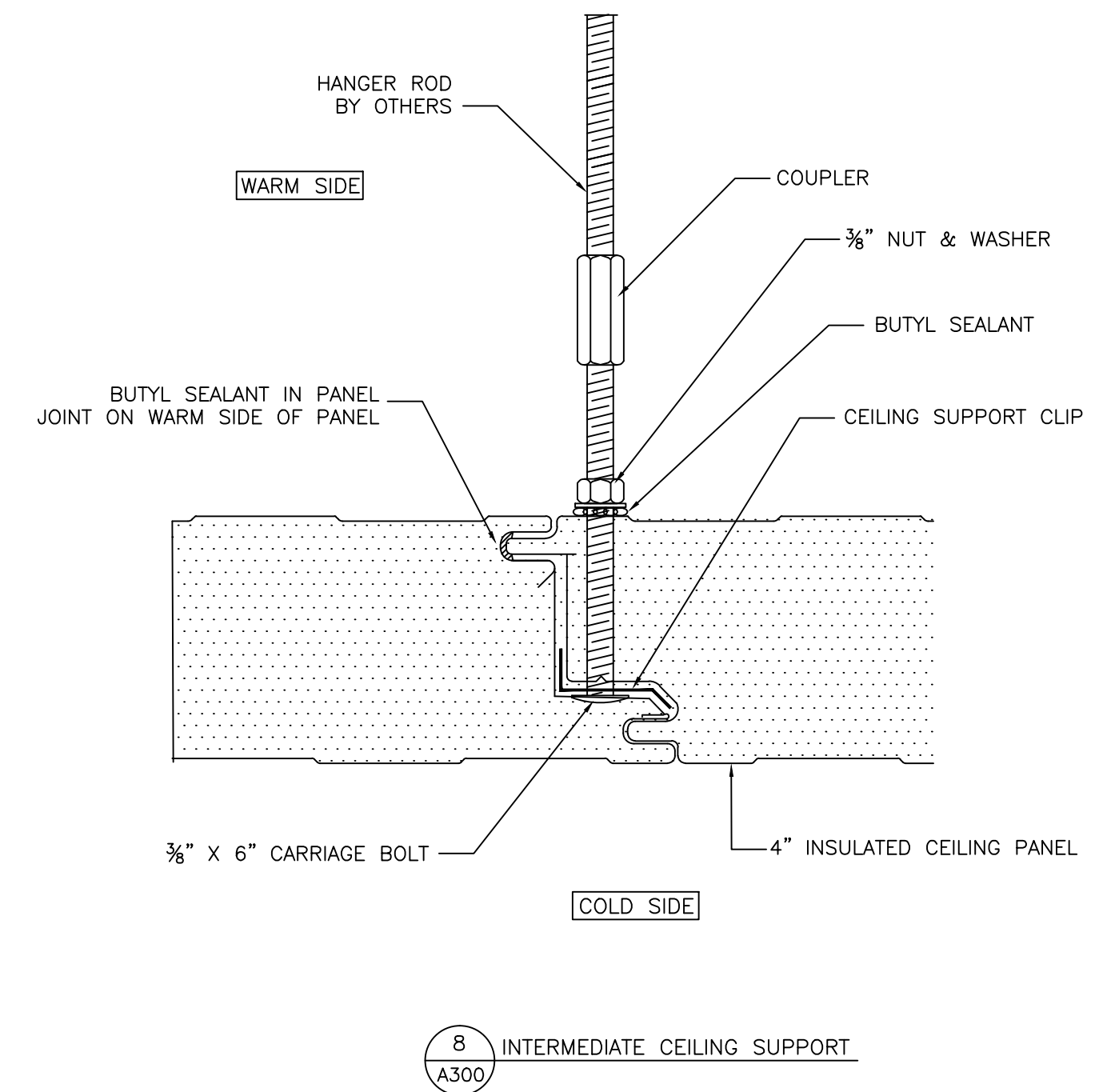

NO.	REVISION	BY	DATE

Barr Inc.
1423 Planeview Drive
Oshkosh, WI 54904
920-231-1711 Phone

20' x 40' x 8'-4"
Drive-In Cooler

TOLERANCES UNLESS SPECIFIED
FRACTIONAL DECIMAL .015 X" ± 0'30" ANGLE
X/X" ± 1/32" .XXX ± .005 XXX ± 0'05"
.XXXX ± .001

Draftsman is not responsible for panel heights, quantities and/or dimensions. Contractor to verify all information.

WALL DETAILS

DR. BY: KRZ
DATE: 8/30/2016
SCALE: NTS
CHECKED BY:
SHEET NO. A300